

Chapter 12

Network Organization and Architecture

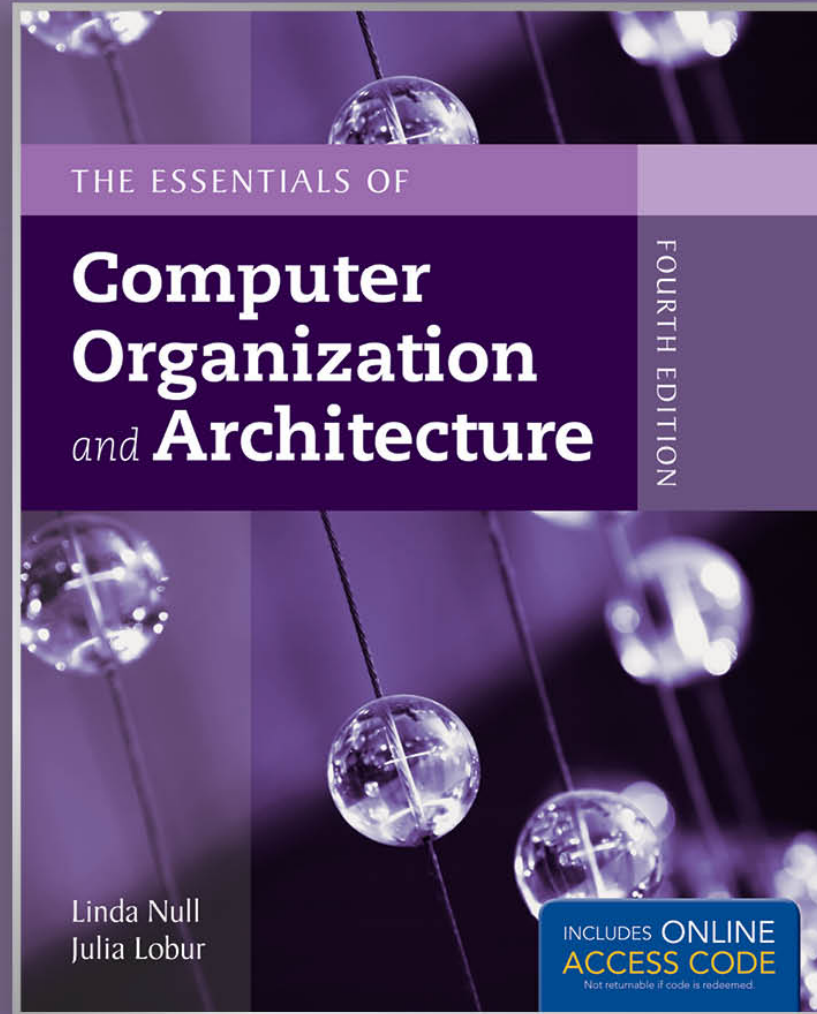

Chapter 12 Objectives



- Learn the basic physical components of networks.
- Become familiar with routing protocols.

12.6 Network Organization



- Computer networks are often classified according to their geographic service areas.
- The smallest networks are *local area networks* (LANs). LANs are typically used in a single building, or a group of buildings that are near each other.
- *Metropolitan area networks* (MANs) are networks that cover a city and its environs.
 - LANs are becoming faster and more easily integrated with WAN technology, it is conceivable that someday the concept of a MAN may disappear entirely.
- *Wide area networks* (WANs) can cover multiple cities, or span the entire world.

12.4 Network Protocols I

ISO/OSI Reference Model

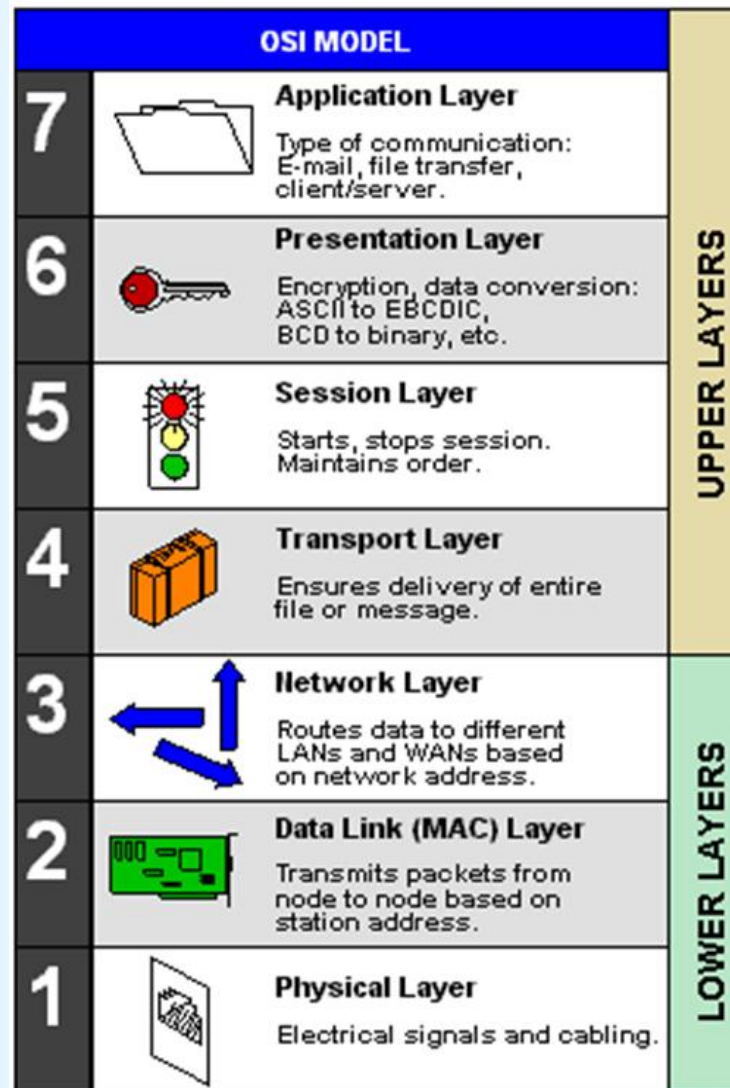

UPPER LAYERS

End-to-end
layers

These layers only exist in the
host processors at the ends of
the connection.

LOWER LAYERS

Device-to-
device layers

These layers exist at the ends of
the connection and also in the
intermediate nodes that make up
the path.

12.6 Network Organization



- In this section, we examine the physical network components common to LANs, MANs and WANs.
- We start at the lowest level of network organization, the physical medium level, Layer 1.
- There are two general types of communications media: **Guided** transmission media and **unguided** transmission media.
- **Unguided** (wireless) **media** broadcast data over the airwaves using infrared, microwave, satellite, or broadcast radio carrier signals.

12.6 Network Organization



- **Guided media** are physical connectors such as copper wire or fiber optic cable that directly connect to each network node.
- The electrical phenomena that work against the accurate transmission of signals are called **noise**.
- Signal and noise strengths are both measured in **decibels** (dB).
- Cables are rated according to how well they convey signals at different frequencies in the presence of noise.

12.6 Network Organization



- The *bandwidth* of a medium is technically the range of frequencies that it can carry, measured in Hertz (cycles per second).
- In *digital communications*, bandwidth is the general term for the information-carrying capacity of a medium, measured in *bits per second* (bps).
- Another important measure is *bit error rate* (*BER*), which is the ratio of the number of bits received in error to the total number of bits received.
- The Gigabit Ethernet standard specifies a BER less than $1/10^{12}$. An upcoming wireless base station standard requires a BER of better than $1/10^{15}$.

12.6 Network Organization

- *Coaxial cable* was once the medium of choice for data communications.
- It can carry signals up to trillions of cycles per second with low attenuation (weakening).
 - Today, it is used mostly for broadcast and closed circuit television applications.

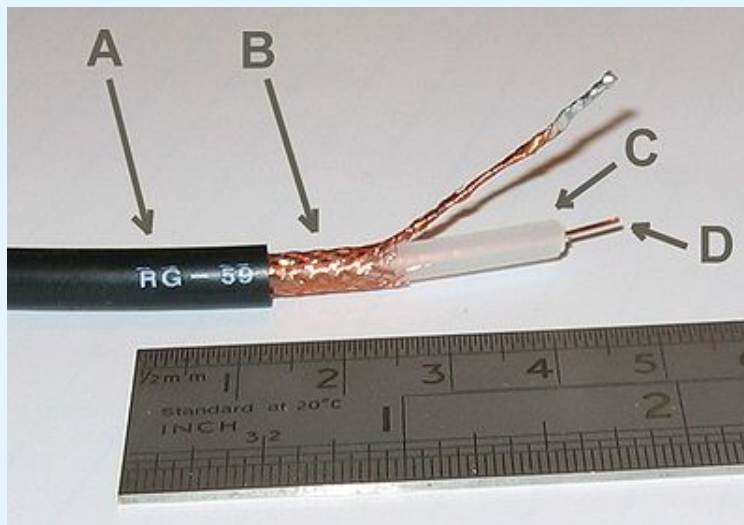

- A: Outer plastic sheath
- B: Woven copper shield
- C: Inner dielectric insulator
- D: Copper core (central conductor)

12.6 Network Organization

- **Twisted pair** cabling, containing two twisted wire pairs, is found in most local area network installations today. One of the wires is used for sending data, the other for receiving.
- It comes in two varieties: **shielded** and **unshielded**. Unshielded twisted pair (UTP) is the most popular.

The twists in the cable reduce electromagnetic interference while the shielding protects the cable from outside interference.

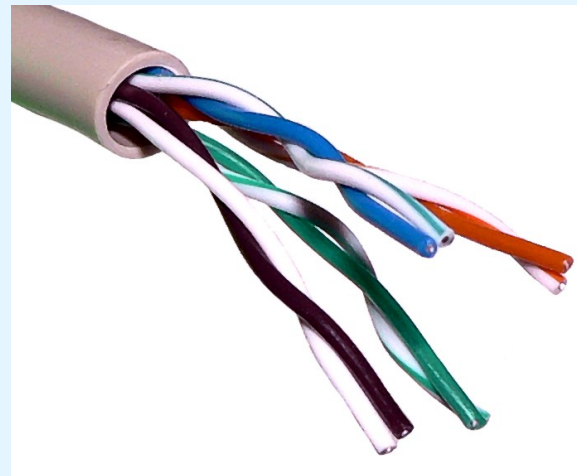

12.6 Network Organization

- **Optical fiber network** media can carry signals faster and farther than either twisted pair or coaxial cable.
- Fiber-optic cable is theoretically able to support frequencies in the terahertz range, but transmission speeds are more commonly in the range of about two gigahertz, carried over runs of 10 to 100 Km (without repeaters).
- Optical cable consists of bundles of thin (1.5 to 125 μm) **glass or plastic** strands surrounded by a protective plastic sheath.

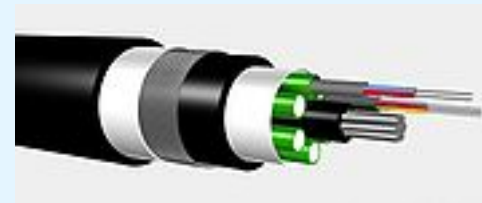

12.6 Network Organization



- A fiber-optic strand is a conductor of **light**, as copper is a conductor of **electricity**.
- Fiber-optic media offer many advantages over copper, the most obvious being its enormous signal-carrying capacity.
- Fiber optic is small and lightweight, one fiber being capable of replacing hundreds of pairs of copper wires.
- But optical cable is fragile and costly to purchase and install. Because of this, fiber is most often used as network **backbone** cable, which bears the traffic of hundreds or thousands of users.

12.6 Network Organization

- Optical fiber supports three different transmission modes depending on the type of fiber used.
- *Single-mode* fiber provides the fastest data rates over the longest distances. It passes light at only one wavelength, typically, 850, 1300 or 1500 nanometers.

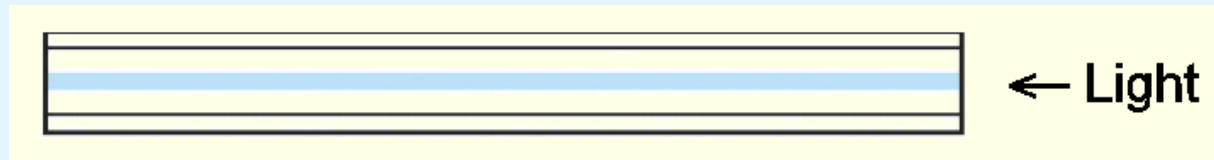

12.6 Network Organization

- *Multimode* fiber can carry several different light wavelengths simultaneously through a larger fiber core.
- The laser light waves bounce off the sides of the fiber core, causing greater attenuation (weakening) than single-mode fiber.

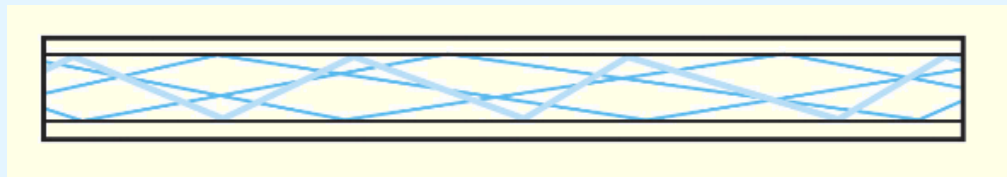

12.6 Network Organization

- *Multimode graded index* fiber also supports multiple wavelengths concurrently, but it does so in a more controlled manner than regular multimode fiber
- Unlike regular multimode fiber, light waves are confined to the area of the optical fiber that is suitable to propagating its particular wavelength (using concentric layers of plastic or glass).
- Thus, different wavelengths concurrently transmitted through the fiber do not interfere with each other.

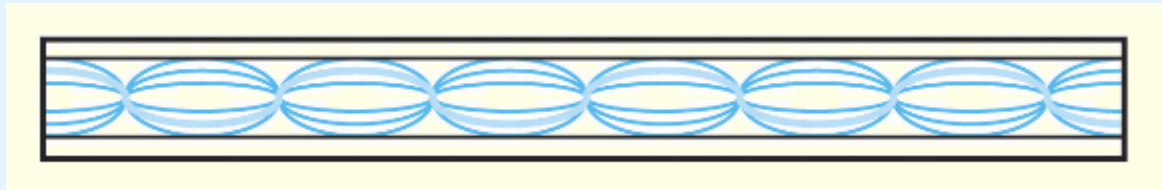

12.6 Network Organization



- **Unguided data communications** media transmit bytes over carrier waves such as those provided by cellular telephone networks, Bluetooth, and the 802.11 family of wireless local area network standards.
 - There are others, including free space optical lasers, microwaves, and satellite communications, to name a few.
- **Cellular wireless networks** use a cellular telephone network to transmit data.
- First generation technology allowed a maximum transmission rate of around 1 Mbps.

12.6 Network Organization



- Cell network data technology is now in its fourth generation (4G).
- Transmission rates up to 150 Mbps are supported.
- 4G also supports a wide array of equipment, including the integration of low-Earth-orbiting satellites into a unified system.

12.6 Network Organization

- **Bluetooth** was first conceived by Ericsson in 1994.
- Bluetooth's purpose is to connect small peripheral devices with a nearby host.
 - Examples include mice, keyboards, printers, and cameras.
- The collection of these devices forms a *personal area network* (PAN), or *piconet*.



USB Bluetooth adapter

12.6 Network Organization



- Wireless local area networks (WLANs) are slower than their wired counterparts, but they make up for this in their versatility.
 - A WLAN can be set up just about anywhere.

12.6 Network Organization



- WLANs consist of a collection of wireless access points (WAPs) that broadcast to nearby computer nodes.
- Distances are limited by ambient electromagnetic interference and obstructions such as walls.
- Connection speeds decrease as distance and obstructions increase.
- Security continues to be a concern even when the 128 bit encryption mode of **wired equivalent protocol (WEP)** is employed.
 - Some security experts believe that it is impossible to make a WLAN as secure as a wired LAN.

12.6 Network Organization



- Transmission media are connected to clients, hosts and other network devices through **network interfaces**.
- Because these interfaces are often implemented on removable circuit boards, they are commonly called ***network interface cards***, or simply ***NICs***.
- A NIC usually embodies the lowest three layers of the OSI protocol stack.
- NICs attach directly to a system's main bus or dedicated I/O bus.

12.6 Network Organization

- NIC

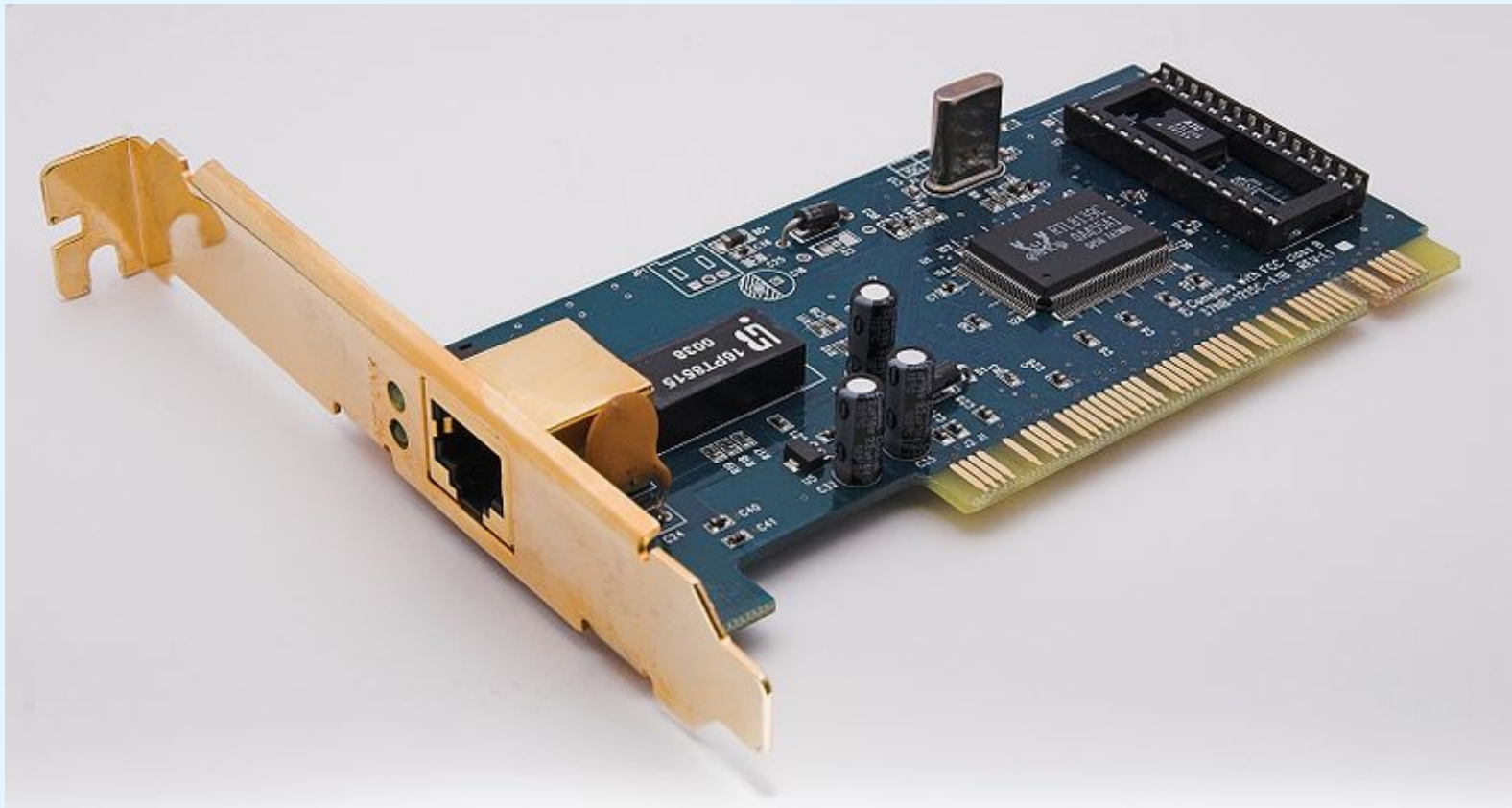

12.6 Network Organization



- Every network card has a unique 6-byte MAC (*Media Access Control*) address burned into its circuits. For example, 00:23:6c:97:38:de.
 - The first three bytes are the manufacturer's identification number, which is designated by the IEEE. The last three bytes are a unique identifier assigned to the NIC by the manufacturer.
- Network protocol layers map this physical MAC address to at least one logical address.
- It is possible for one computer (logical address) to have two or more NICs, but each NIC will have a distinct MAC address.

12.6 Network Organization

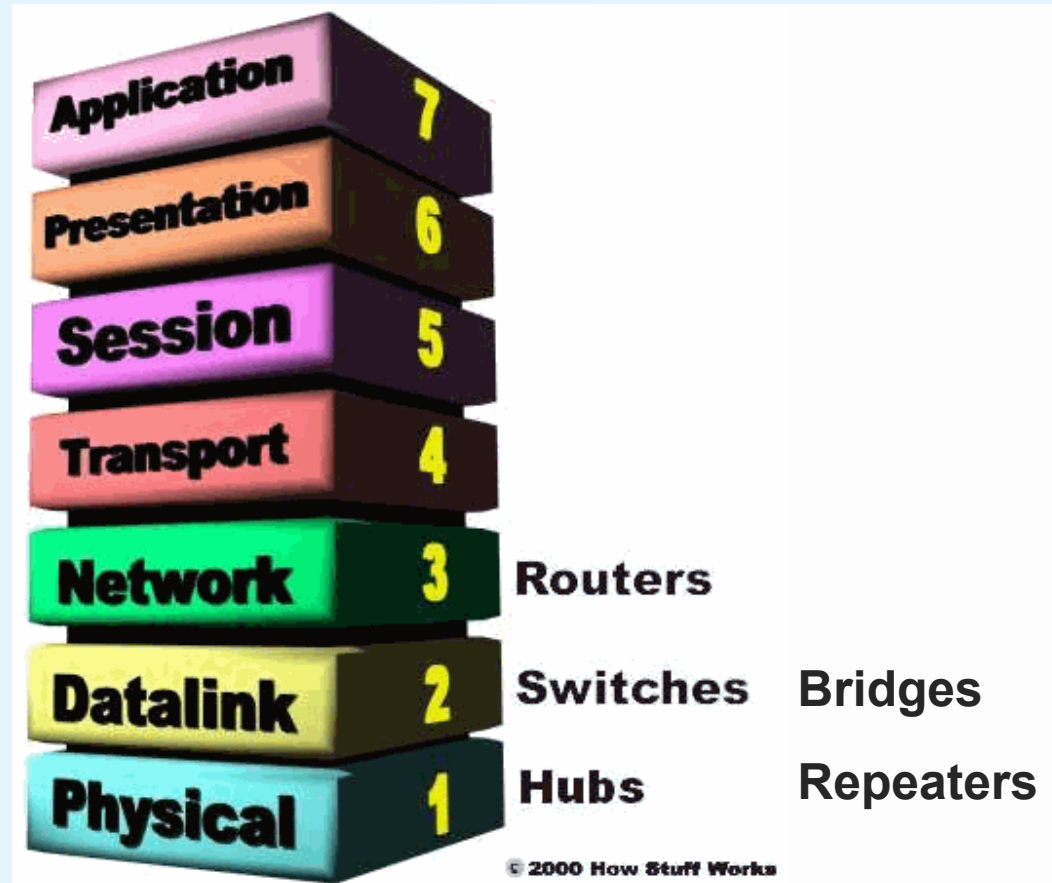

12.6 Network Organization

- Signal attenuation (weakening) is corrected by *repeaters* that *amplify signals* in physical cabling.
- Repeaters are part of the network medium (Layer 1).
 - In theory, they are dumb devices functioning entirely without human intervention. However, some repeaters now offer higher-level services to assist with network management and troubleshooting.

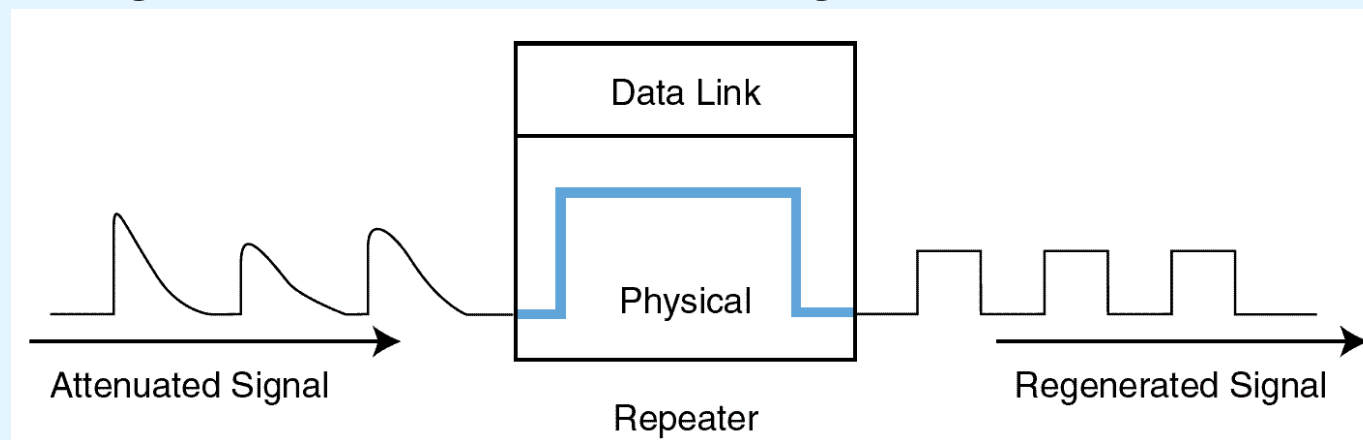

12.6 Network Organization

- Repeater



- Wireless home repeater



12.6 Network Organization

- *Hubs* are also Physical layer devices, but they can have many ports for input and output.
- They receive incoming packets from one or more locations and broadcast the packets to one or more devices on the network.
- Hubs allow computers to be joined to form *network segments*.

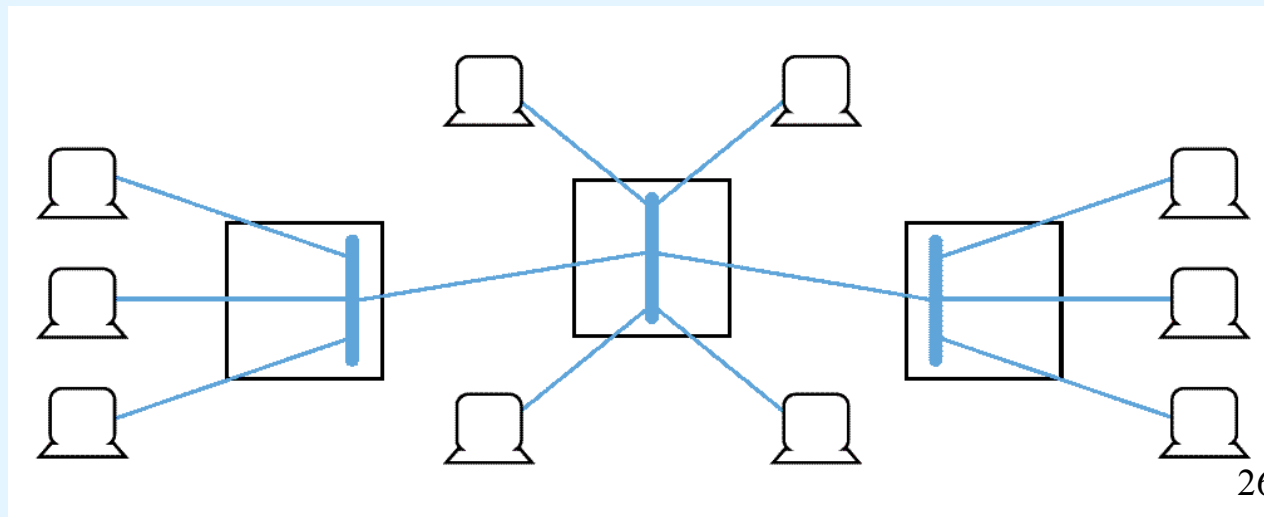

12.6 Network Organization

- Hub



12.6 Network Organization



- A *switch* is a Layer 2 device that creates a point-to-point connection between one of its input ports and one of its output ports. In contrast to a hub, a switch can handle more than one packet at a time.
- Switches contain buffered input ports, an equal number of output ports, a *switching fabric* and digital hardware that interprets address information encoded on network frames as they arrive in the input buffers.
- Because all switching functions are carried out in hardware, switches are the preferred devices for interconnecting high-performance network components.

12.6 Network Organization

- Switch



12.6 Network Organization

- *Bridges* are Layer 2 devices that join two similar types of networks so they look like one network. All computers on the network belong to the same **subnet**.
- Bridges can connect different media having different media access control protocols, but the protocol from the MAC layer through all higher layers in the OSI stack must be identical in both segments.

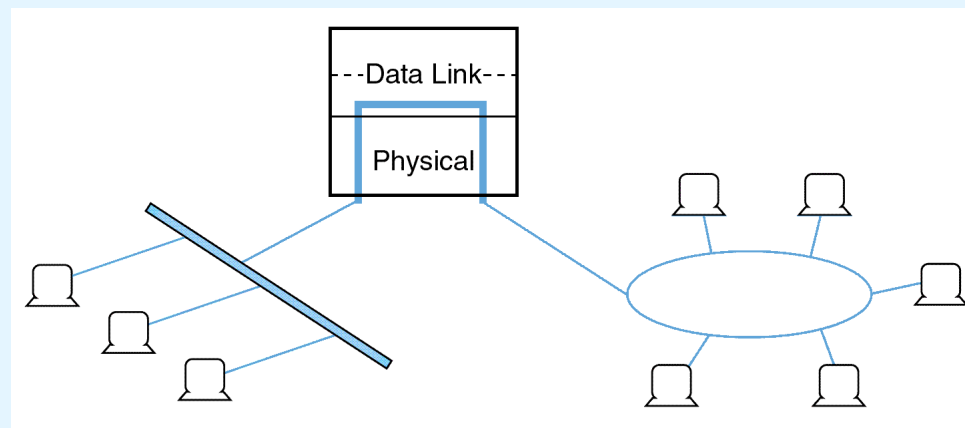

12.6 Network Organization

- Wireless bridge



12.6 Network Organization



- A *router* is a device connected to at least two networks that determines the destination to which a packet should be forwarded.
- Routers are designed specifically to connect two networks together, typically a LAN to a WAN.
- Routers are by definition **Layer 3** devices, they can bridge different network media types and connect different network protocols running at Layer 3 and below.
- Routers are sometimes referred to as “**intermediate systems**” or “**gateways**” in Internet standards literature.

12.6 Network Organization

- Wireless router



12.6 Network Organization

- Routers are complex devices because they contain buffers, switching logic, memory, and processing power to calculate the best way to send a packet to its destination.

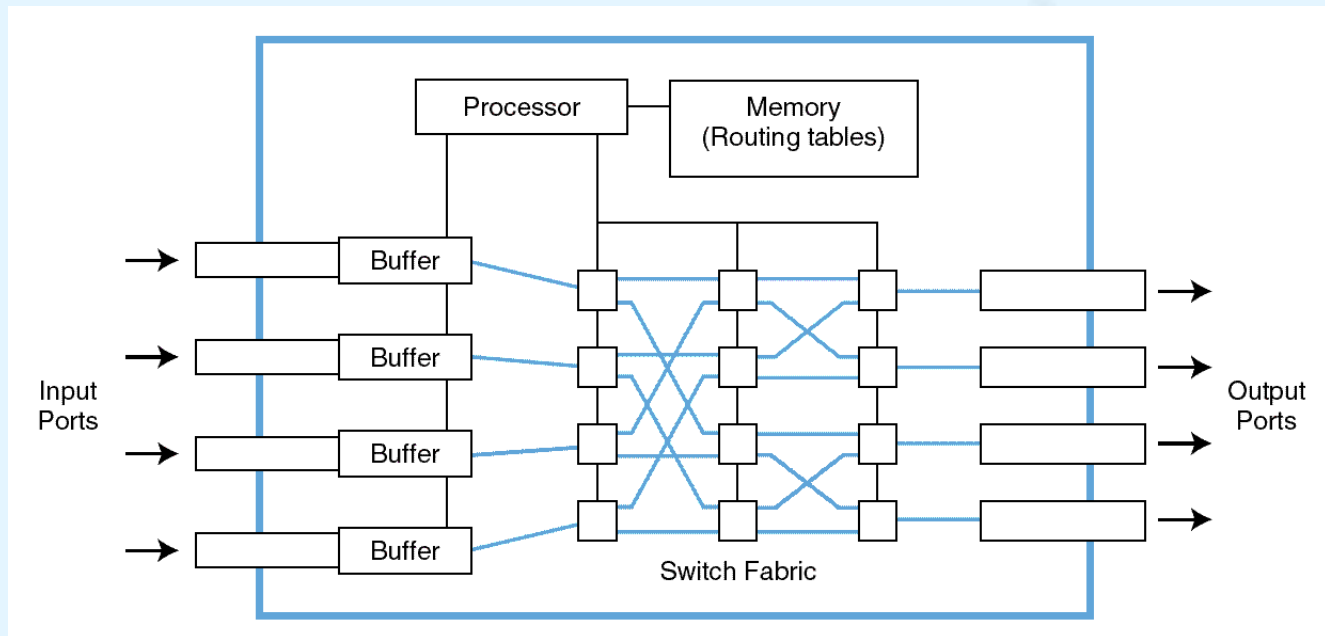

12.6 Network Organization

- *Dynamic routers* automatically set up routes and respond to the changes in the network.
- They explore their networks through information exchanges with other routers on the network.
- The information packets exchanged by the routers reveal their addresses and costs of getting from one point to another.
- Using this information, each router assembles a table of values in memory.
- Typically, each destination node is listed along with the neighboring, or *next-hop*, router to which it is connected.

12.6 Network Organization



- When creating their tables, dynamic routers consider one of two metrics. They can use either the **distance to travel** between two nodes, or they can use the condition of the network in terms of **measured latency** (delay).
- The algorithms using the first metric are **distance vector routing** algorithms. **Link state routing** algorithms use the second metric.
- **Distance vector routing** is easy to implement, but it suffers from high traffic and the **count-to-infinity** problem where an infinite loop finds its way into the routing tables.

12.6 Network Organization

Network with 4 routers and 10 end nodes.

Routing tables from Router 1 and Router 3 are used for building the routing table for Router 2.

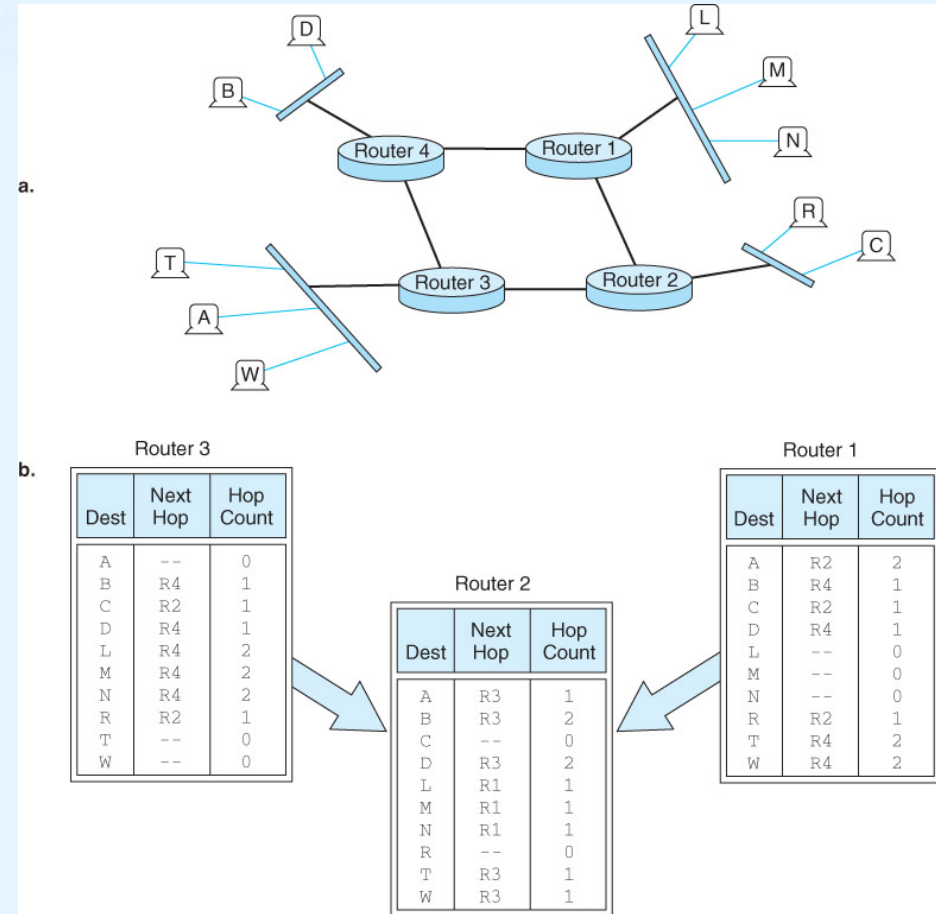

12.6 Network Organization

- **Count-to-infinity** example.

Distances from A and B to C are stored in A and B.

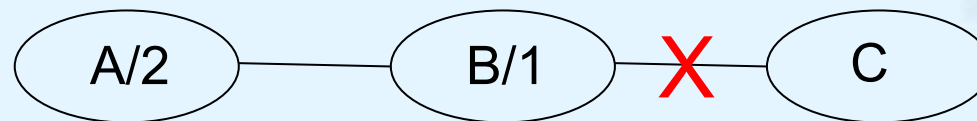

If the link from B to C breaks down, A informs B about a route to C. So B registers a new (but wrong) route to C.

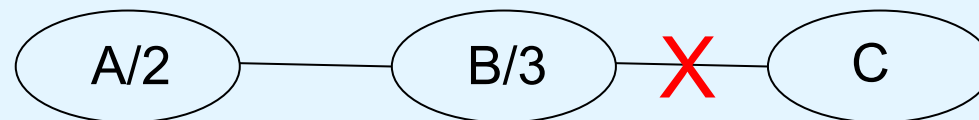

12.6 Network Organization

B informs A about a route to C.

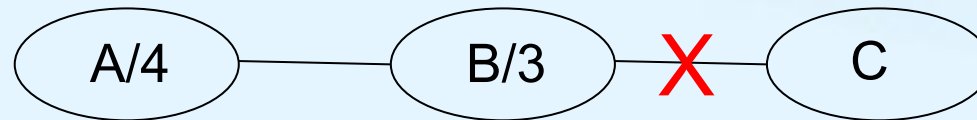

A informs B about a route to C.

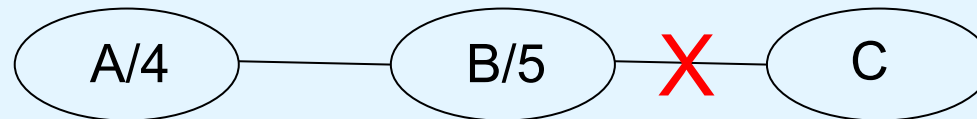

And so on

12.6 Network Organization



- In **link state routing**, each router discovers the speed of the lines between itself and **its neighboring routers** by periodically sending out *Hello* packets.
- After the *Hello* replies are received, the router assembles the timings into a table of link state values.
- This table is then broadcast to all other routers, **except its adjacent neighbors**. Each router tells the world about its neighbors.
- Eventually, all routers within the routing domain end up with identical routing tables.
- All routers then use this information to calculate the optimal path to every destination in its routing table.

Chapter 12 Conclusion



- Network organization consists of physical (or wireless) media, NICs, modems, repeaters, hubs, switches, routers, and computers. Each has its place in the OSI RM.

End of Chapter 12